

SEKUNDARNI VZDUCH
Sekundärluft

PRIMARNI VZDUCH
Primärluft

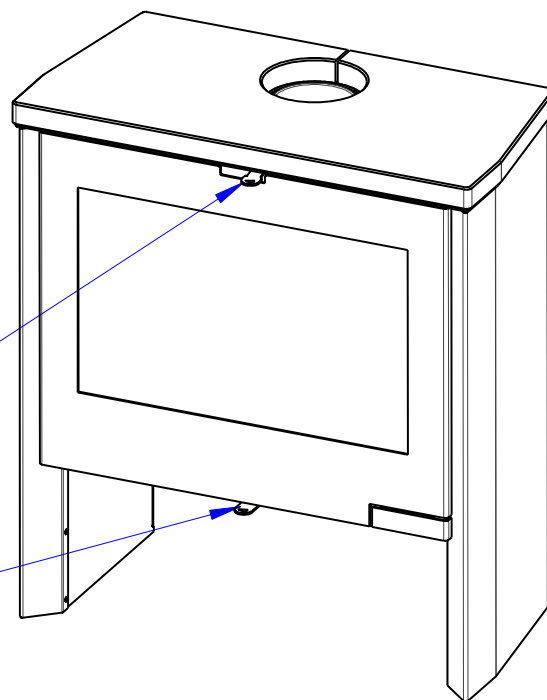

Declared qualities stated

Harmonised technical specification	✓ EN 13240 EN 13229	EN 16510 ✓ Ecodesign	DIN+ BlmSchV2	DIBt ✓ 15a B-VG 2015	
Classification of appliance				Type BE	
Energy efficiency (η_{nom})				79,5	%
The energy efficiency index				105,2	
Energy label				A	
Fuel				Wood logs	
Fuel length				250-350	mm
Average fuel consumption				2,818	kg/h
Allowed fuel dose				3,5	kg/h
Fuel supply interval				1 hour	
Amount of combustion air				35,7	m ³ /h
Nominal output (P_{nom})				9,0	kW
Hot-water exchanger output (P_{Wnom})				---	kW
Maximum operating overpressure (p_w)				---	bar
Dry flue gas mass flow rate to calculate the flue gas path				6,7	g/s
Flue gas temperature (T_{nom})				326	°C
Mean flue gas temperature after throat				407	°C
Flue draught (p_{nom})				12	Pa
Chimney temperature class				T400	
Connection to the common chimney				Yes	
Storage of fuel in the wood shed area				No	
Maximum warming of the wood in the wood shed				---	°C
Dust $O_2 = 13\%$ (PM_{nom})				24	mg/Nm ³
Emissions of gases of combustion (CO in the flue gases at $O_2 = 13\%$) (CO_{nom})				0,1204 1481	% mg/Nm ³
OGC $O_2 = 13\%$ (OGC_{nom})				104	mg/Nm ³
NOx $O_2 = 13\%$ (NO_{xnom})				87	mg/Nm ³
Automatic regulation unit of burning				---	
Power consumption (W)				---	W
Standing air loss (V_h)				---	m ³ /h
Intermittent operation (INT) / Continuous operation (CON)				INT	

Basic technical data

Principal dimensions Height (H) Width (W) Length (L)	920 820 420	mm
Combustion chamber dimensions Height (H) Width (W) Length (L)	460 620 285	mm
Fireplace door dimensions Height (H) Width (W) Length (L)	--- --- ---	mm
Axis height of the rear (side) outlet	762	mm
Volume of hot-water exchanger	---	l
Flue diameter	150	mm
Diameter of flue throat (D_{out})	150	mm
Diameter of external air connection		mm
Weight	176	kg
Area of Inlet ventilation grille	---	cm ²
Area of Outlet ventilation grille	---	cm ²

Distances from flammable materials

with un-insulated flue pipe (provided on the product label)

Note

Back (d_R)	100	mm
Front (d_P)	800	mm
Front to the floor (d_F)	---	mm
Side (d_S)	100	mm
Side with glass (d_{S1})	---	mm
Side - niche (d_{S2})	---	mm
Side - location 45° (d_{S3})	---	mm
Side radiation (d_L)	---	mm
From the floor (d_B)	---	mm
From the ceiling (d_C)	1000	mm

Distances from flammable materials with insulated flue pipe *

Back (d_R)	---	mm
Side (d_S)	---	mm

Distances from flammable materials with insulated flue pipe and hanging plate (shielding) *

Back (d_R)	---	mm
Side (d_S)	---	mm

Distances from nonflammable materials

Back (d_{Rnon})	80	mm
Side (d_{Snon})	100	mm
Side - niche (d_{S2non})	---	mm

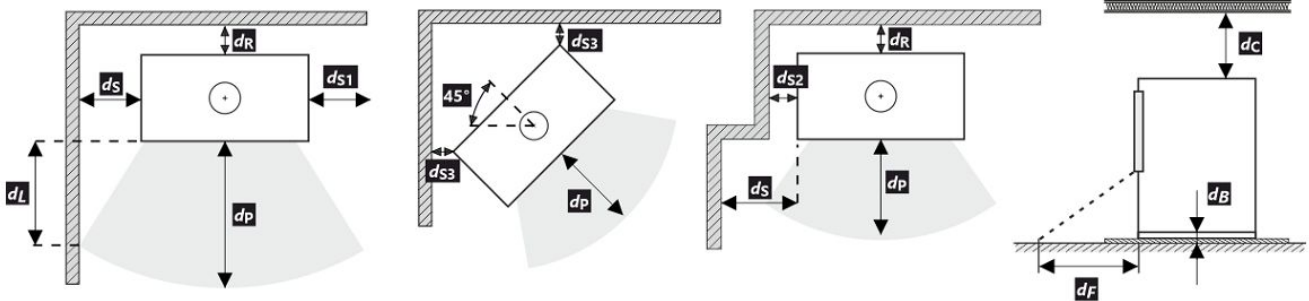

All local regulations, including regulations relating to national and European standards, must be observed during the installation and operation of the product.

- * The distance assumes the use of an insulated flue pipe with a minimum insulation thickness of 25 mm up to the product.

Deklarierte Produkteigenschaften

Harmonisierte technische Spezifikation	✓ EN 13240 EN 13229	EN 16510 ✓ Ecodesign	DIN+ BImSchV2	DIBt ✓ 15a B-VG 2015
Produktklassifizierung	Type BE			
Energiewirkungsgrad (η_{nom})	79,5 %			
Energieeffizienzindex	105,2			
Energielabel	A			
Brennstoff	Scheitholz			
Brennstofflänge	250-350 mm			
Durchschnittlicher Brennstoffverbrauch	2,818 kg/h			
Zulässiger Brennstoffverbrauch	3,5 kg/h			
Brennstofflieferintervall	1 Stunde			
Verbrennungsluftmenge	35,7 m ³ /h			
Nennwärmeleistung (P_{nom})	9,0 kW			
Wärmetauscherleistung (P_{Wnom})	--- kW			
Maximaler Betriebsüberdruck (p_w)	--- bar			
Rauchgasmassenstrom (trocken) für die Berechnung der Rauchgaswege	6,7 g/s			
Durchschnittliche Abgastemperatur (T_{nom})	326 °C			
Durchschnittliche Rauchgastemperatur hinter dem Stutzen	407 °C			
Förderdruck (p_{nom})	12 Pa			
Temperaturklasse	T400			
Mehrfachbelegung	Ja			
Lagerung von Brennstoff im Holzfach	Nein			
Maximale Erwärmung des Holzes im Holzfach	--- °C			
Feinstaub O ₂ = 13 % (PM_{nom})	24 mg/Nm ³			
Abgasemission (CO in den Abgasen bei O ₂ = 13 %) (CO_{nom})	0,1204 % 1481 mg/Nm ³			
OGC O ₂ = 13 % (OGC_{nom})	104 mg/Nm ³			
NO _x O ₂ = 13 % (NO_{xnom})	87 mg/Nm ³			
Automatische Abbrandsteuerung	---			
Stromverbrauch (W)	--- W			
Ständiger Luftverlust (V_h)	--- m ³ _N /h			
Intervallbetrieb (INT) / Dauerbetrieb (CON)	INT			

Technische Grunddaten

Hauptabmessungen Höhe (H) Breite (W) Tiefe (L)	920 820 420	mm
Abmessungen der Brennkammer Höhe (H) Breite (W) Tiefe (L)	460 620 285	mm
Abmessungen der Feuerraumtür Höhe (H) Breite (W) Tiefe (L)	--- --- ---	mm
Achshöhe hinterer (seitlichen) Rauchrohanschluss	762	mm
Volumen Wärmetauscher	---	l
Rauchrohrdurchmesser	150	mm
Abgasstutzen (D_{out})	150	mm
Durchmesser zentrale Luftzufuhr		mm
Gewicht	176	kg
Fläche Zuluftgitter	---	cm ²
Fläche Abluftgitter	---	cm ²

Abstand zu brennbaren Materialien

mit unisoliertem Rauchrohr (auf dem Typenschild angegeben)

Bemerkung

Rückwand (d_R)	100	mm
Strahlungsbereich (d_P)	800	mm
Strahlungsbereich zum Boden (d_F)	---	mm
Seitenwände (d_S)	100	mm
Seite mit Glas (d_{S1})	---	mm
Seite – Nische (d_{S2})	---	mm
Seite – Ausrichtung 45° (d_{S3})	---	mm
Seitliche Strahlung (d_L)	---	mm
Von dem Boden (d_B)	---	mm
Von der Decke (d_C)	1000	mm

Abstand zu brennbaren Materialien mit isoliertem Rauchrohr *

Rückwand (d_R)	---	mm
Seitenwände (d_S)	---	mm

Abstand zu brennbaren Materialien mit isoliertem Rauchrohr und Aufhängeblech (Abschirmung) *

Rückwand (d_R)	---	mm
Seitenwände (d_S)	---	mm

Abstand zu nicht brennbaren Materialien

Rückwand (d_{Rnon})	80	mm
Seitenwände (d_{Snon})	100	mm
Seite – Nische (d_{S2non})	---	mm

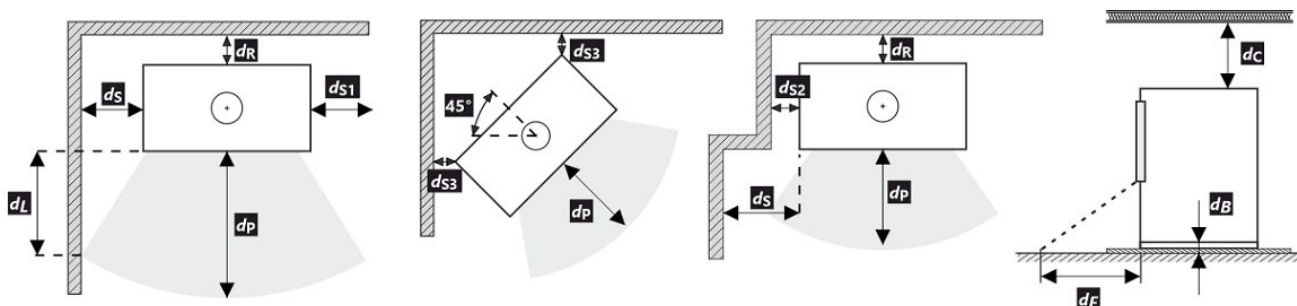

Bei der Installation und dem Betrieb des Ofens sind alle örtlichen Vorschriften sowie nationale und europäische Normen zu beachten.

- * Der Abstand setzt die Verwendung eines isolierten Rauchrohrs mit einer Mindestdämmstärke von 25 mm bis zum Produkt voraus.

Caractéristiques déclarées du produit

Norme(s) Européennes	✓ EN 13240 EN 13229	EN 16510 ✓ Ecodesign	DIN+ BlmSchV2	DIBt ✓ 15a B-VG 2015	
Classification de l'appareil					Type BE
Rendement énergétique (N_{nom})					79,5 %
L'indice d'efficacité énergétique EEI					105,2
Label énergétique					A
Combustible					Bûches
Longueur recommandée de bûches					250-350 mm
Consommation moyenne de combustible					2,818 kg/h
Charge en bois autorisé					3,5 kg/h
Intervalle entre les chargements de combustible					1 heure
Débit massique des fumées					35,7 m ³ /h
Puissance nominale (P_{nom})					9,0 kW
Puissance nominale de l'échangeur (P_{Wnom})					--- kW
Surpression maximale de fonctionnement (p_w)					--- bar
Débit massique des gaz de combustion secs pour le calcul des gaz de combustion					6,7 g/s
Température moyenne des résidus de combustion (T_{nom})					326 °C
Température moyenne des résidus de combustion derrière la sortie					407 °C
Tirage de conduit de fumée (p_{nom})					12 Pa
Classe de température					T400
Raccordement à une cheminée collective					Oui
Stockage du combustible dans range bûches					Non
Réchauffement maximal du bois dans range bûches					--- °C
Poussière O ₂ = 13 % (PM_{nom})					24 mg/Nm ³
Résidus de combustion émis (CO dans les résidus de combustion pour O ₂ = 13 %) (CO_{nom})					0,1204 % 1481 mg/Nm ³
OGC O ₂ = 13 % (OGC_{nom})					104 mg/Nm ³
NOx O ₂ = 13 % (NO_{xnom})					87 mg/Nm ³
Régulation automatique de la combustion					---
La consommation d'électricité (W)					--- W
Standing air loss (V_h)					--- m ³ /h
Fonctionnement par intermittence (INT) / Service ininterrompu (CON)					INT

Données techniques de base

Dimensions principales Hauteur (H) Largeur (W) Profondeur (L)	920 820 420	mm
Dimensions de la chambre de combustion Hauteur (H) Largeur (W) Profondeur (L)	460 620 285	mm
Dimensions de la porte (du foyer) Hauteur (H) Largeur (W) Profondeur (L)	--- --- ---	mm
Hauteur de l'axe de la sortie arrière (latérale)	762	mm
Volume de l'échangeur de chaleur	---	l
Diamètre du conduit de fumée	150	mm
Diamètre de buse d'air de combustion (D_{out})	150	mm
Diamètre de l'arrivée d'air centrale		mm
Poids	176	kg
Zone de la grille de ventilation d'entrée	---	cm ²
Zone de la grille de ventilation de sortie	---	cm ²

Distance par rapport aux matériaux combustibles

pour un conduit de fum. non isolé (conform. aux la plaque signalétique)

Note

Arrière (d_R)	100	mm
Avant (d_P)	800	mm
Avant (par rapport au sol) (d_F)	---	mm
Latéral (d_S)	100	mm
Latéral avec vitre (d_{S1})	---	mm
Latéral – niche (d_{S2})	---	mm
Latéral – emplacement 45° (d_{S3})	---	mm
Rayonnement latéral (d_L)	---	mm
Depuis le sol (d_B)	---	mm
Plafond (d_C)	1000	mm

Distance par rapport aux matériaux combustibles pour un conduit de fumée isolé *

Arrière (d_R)	---	mm
Latéral (d_S)	---	mm

Distance par rapport aux matériaux combustibles pour un conduit de fumée isolé une plaque de suspension *

Arrière (d_R)	---	mm
Latéral (d_S)	---	mm

Distance par rapport aux matériaux non combustibles

Arrière (d_{Rnon})	80	mm
Latéral (d_{Snon})	100	mm
Latéral – niche (d_{S2non})	---	mm

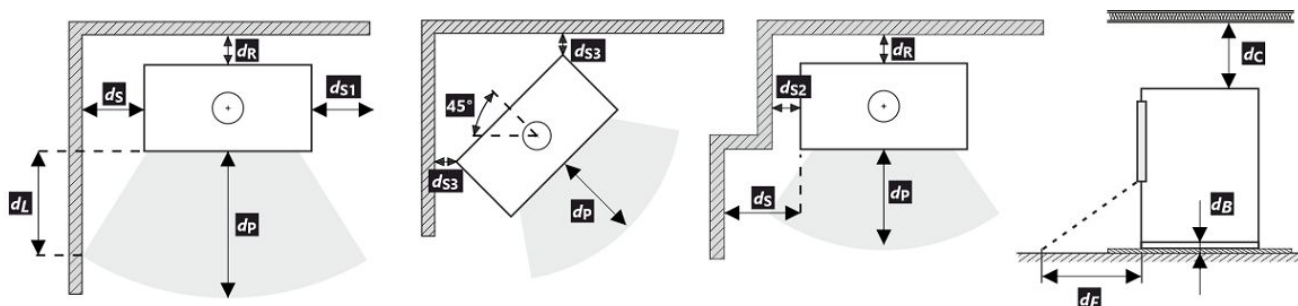

Lors de l'installation et de l'utilisation du produit, toutes les réglementations locales doivent être respectées, y compris celles relatives aux normes nationales et européennes.

- * La distance suppose l'utilisation d'un conduit de fumée isolé avec une épaisseur d'isolation minimale de 25 mm jusqu'au produit.

Proprietà dichiarate del prodotto

Specificazioni tecniche armonizzate	✓ EN 13240 EN 13229	EN 16510 ✓ Ecodesign	DIN+ BlmSchV2	DIBt ✓ 15a B-VG 2015	
Classificazione del prodotto					Type BE
Efficienza energetica (η_{nom})					79,5 %
Indice di efficienza prodotto					105,2
Etichetta energetica					A
Combustibile					Legna
Combustibile – lunghezza					250-350 mm
Consumo medio di combustibile					2,818 kg/h
Dose ammessa di combustibile					3,5 kg/h
Intervallo di aggiunta di combustibile					1 ora
Quantità di aria di combustione					35,7 m ³ /h
Protenza nominale (P_{nom})					9,0 kW
Protenza nominale dello scambiatore di acqua calda (P_{Wnom})					--- kW
Sovrappressione massima di funzionamento (p_w)					--- bar
Portata dei fumi di scarico secchi per il calcolo delle condotte dei fumi di scarico					6,7 g/s
Temperatura dei gas combusti alla potenza calorica nominale (T_{nom})					326 °C
Temp. media dei gas di scarico al collo alla potenza termica nominale					407 °C
Tiro di esercizio (p_{nom})					12 Pa
Classe di temperatura del camino					T400
Collegamento al camino collettivo					Sì
Stoccaggio del combustibile nell'area della stufa a legna					No
Riscaldamento massimo della legna nella stufa a legna					--- °C
Polvere O ₂ = 13 % (PM_{nom})					24 mg/Nm ³
Emissioni (CO nei gas comburenti all' O ₂ = 13 %)(CO_{nom})					0,1204 % 1481 mg/Nm ³
OGC O ₂ = 13 % (OGC_{nom})					104 mg/Nm ³
NOx O ₂ = 13 % (NO_{Xnom})					87 mg/Nm ³
Controllo automatico della combustione					---
Consumo di energia elettrica (W)					--- W
Perdita d'aria in piedi (V_h)					--- m ³ /h
Funzionamento intermittente (INT) / Funzionamento continuo (CON)					INT

Dati tecnici di base

Dimensioni principali Altezza (H) Larghezza (W) Profondità (L)	920 820 420	mm
Dimensioni della camera di combustione Altezza (H) Larghezza (W) Profondità (L)	460 620 285	mm
Dimensioni dello sportello del focolare Altezza (H) Larghezza (W) Profondità (L)	--- --- ---	mm
Altezza dell'asse dell'uscita posteriore (laterale)	762	mm
Volume dello scambiatore di acqua calda	---	l
Diametro del condotto fumario	150	mm
Diametro del gola della canna fumaria (D_{out})	150	mm
Diametro dell'afflusso centralizzato di aria		mm
Peso	176	kg
Superficie della griglia di aerazione d'ingresso	---	cm ²
Superficie della griglia di aerazione d'uscita	---	cm ²

Distanza di materiali infiammabili

con canna fumaria non isolata (indicato sull'etichetta di produzione)

Nota

Posteriore (d_R)	100	mm
Anteriore (d_P)	800	mm
Anteriore (rispetto al pavimento) (d_F)	---	mm
Laterali (d_S)	100	mm
Vetrata laterale (d_{S1})	---	mm
Laterali - nicchia (d_{S2})	---	mm
Laterali - posizione 45° (d_{S3})	---	mm
Radiazione laterale (d_L)	---	mm
Dal pavimento (d_B)	---	mm
Dal soffitto (d_C)	1000	mm

Distanza di materiali infiammabili con canna fumaria isolata *

Posteriore (d_R)	---	mm
Laterali (d_S)	---	mm

Distanza di materiali infiammabili con canna fumaria isolata una piastra di sospensione *

Posteriore (d_R)	---	mm
Laterali (d_S)	---	mm

Distanza di materiali non infiammabili

Posteriore (d_{Rnon})	80	mm
Laterali (d_{Snon})	100	mm
Laterali - nicchia (d_{S2non})	---	mm

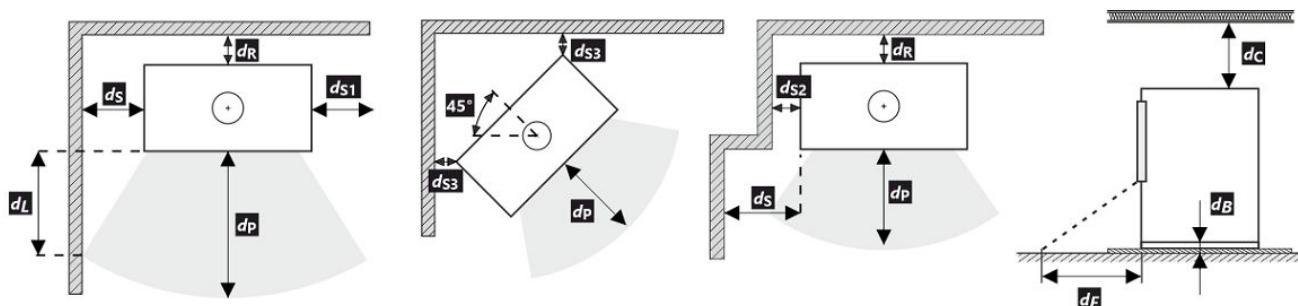

Durante il montaggio e l'uso del prodotto, devono essere rispettate tutte le normative locali, incluse le norme nazionali ed europee.

- * La distanza presuppone l'utilizzo di una canna fumaria isolata con uno spessore minimo di isolamento di 25 mm fino al prodotto.

Deklaracija lastnosti

Harmonizirana tehnična specifikacija	✓ EN 13240 EN 13229	EN 16510 ✓ Ecodesign	DIN+ BlmSchV2	DIBt ✓ 15a B-VG 2015	
Klasifikacija izdelka					Type BE
Energetska učinkovitost (η_{nom})					79,5 %
Indeks energetske učinkovitosti					105,2
Energijska nalepka					A
Gorivo					Drva
Priporočljiva dolžina goriva					250-350 mm
Povprečna poraba lesa					2,818 kg/h
Dovoljena količina lesa					3,5 kg/h
Interval dobave goriva za nazivno moč					1 ura
Zahtevan zrak za izgorevanje					35,7 m ³ /h
Nazivna moč (P_{nom})					9,0 kW
Izhod toplovodnega izmenjevalnika (P_{Wnom})					--- kW
Delovni tlak (p_w)					--- bar
Masni pretok huhih dimnih plinov					6,7 g/s
Srednja temperatura plinov pri nazivni toplotni moči (T_{nom})					326 °C
Srednja temperatura dimnih plinov po grlu pri nazivni toplotni moči					407 °C
Vlek dimnika (p_{nom})					12 Pa
Temperaturni razred kamina					T400
Priključek na skupni dimnik					Da
Skladiščenje goriva v območju peči					Ne
Maksimalno segrevanje lesa v območju peči na drva					--- °C
Prah O ₂ = 13 % (PM_{nom})					24 mg/Nm ³
Emisije izgorevalnih plinov (CO v dimne pline pri O ₂ = 13 %) (CO_{nom})					0,1204 % 1481 mg/Nm ³
OGC O ₂ = 13 % (OGC_{nom})					104 mg/Nm ³
NO _x O ₂ = 13 % (NO_{xnom})					87 mg/Nm ³
Avtomatska regulacija gorenja					---
Poraba električne energije (W)					--- W
Stalna izguba zraka (V_h)					--- m ³ /h
Prekinjeno delovanje (INT) / Nprekinjeno delovanje (CON)					INT

Osnovni tehnični podatki

Dimenzije Višina (H) Širina (W) Globina (L)	920 820 420	mm
Dimenzije zgorevalne komore Višina (H) Širina (W) Globina (L)	460 620 285	mm
Dimenzije vrat peči Višina (H) Širina (W) Globina (L)	--- --- ---	mm
Višina osi zadnjega (stranskega) izpusta	762	mm
Prostornina toplotnega izmenjevalnika	---	l
Premer priključka dimne cevi	150	mm
Premer dimne cevi (D_{out})	150	mm
Zunanji dovod zraka (ZDZ)		mm
Teža	176	kg
Minimalni presek konvektne odprtine za dovod zraka za nazivno moč	---	cm ²
Minimalni presek konvektne odprtine za odvod zraka za nazivno moč	---	cm ²

Varna razdalja od vnetljivega materiala

z neizolirano dimovodno cevjo (navedeno na nalepki izdelka)

Opomba

Zadaj (d_R)	100	mm
Spredaj (d_P)	800	mm
Spredaj do tal (d_F)	---	mm
Stran (d_S)	100	mm
Stran s steklom (d_{S1})	---	mm
Stran – niša (d_{S2})	---	mm
Stran – postavitvev pod kotom 45° (d_{S3})	---	mm
Stransko sevanje (d_L)	---	mm
Od tal (d_B)	---	mm
Od stropa (d_C)	1000	mm

Varna razdalja od vnetljivega materiala z izolirano dimovodno cevjo *

Zadaj (d_R)	---	mm
Stran (d_S)	---	mm

Varna razdalja od vnetljivega materiala z izolirano dimovodno cevjo s pokrивно ploščo (pokrovom) *

Zadaj (d_R)	---	mm
Stran (d_S)	---	mm

Varna razdalja od negorljivega materiala

Zadaj (d_{Rnon})	80	mm
Stran (d_{Snon})	100	mm
Stran – niša (d_{S2non})	---	mm

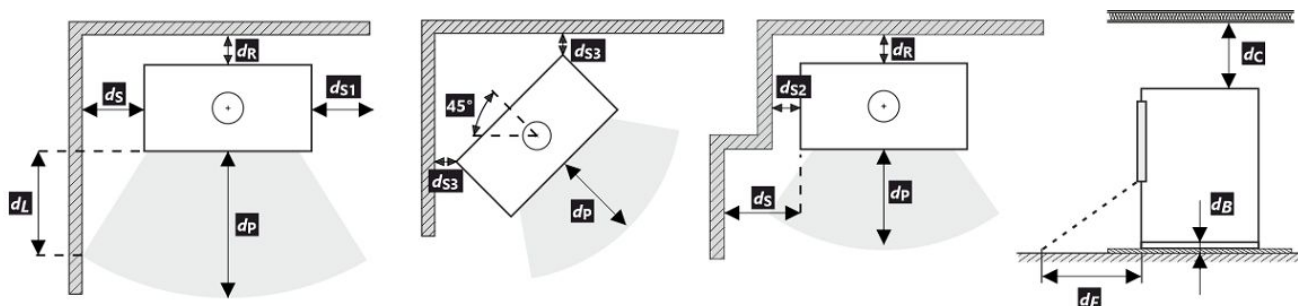

Pri montaži in delovanju izdelka morajo biti upoštevani vsi lokalni predpisi, vključno predpisi, ki se nanašajo na lokalne in Evropske standarde.

- * Razdalja predpostavlja uporabo izolirane dimovodne cevi z najmanjšo debelino izolacije 25 mm do izdelka.

Ilmoitetut ominaisuudet

Yhdenmukaistetut tekniset tiedot	✓ EN 13240 EN 13229	EN 16510 ✓ Ecodesign	DIN+ BlmSchV2	DIBt ✓ 15a B-VG 2015	
Laitteen luokittelu				Type BE	
Energiatehokkuus (N_{nom})				79,5	%
Energiatehokkuusindeksi				105,2	
Energiamerkintä				A	
Polttoaine				Puuhalot	
Polttopuun pituus				250-350	mm
Keskimääräinen polttoaineenkulutus				2,818	kg/h
Sallittu puumäärä				3,5	kg/h
Puun lisäysväli				1 tunti	
Palamisilman määrä				35,7	m ³ /h
Nimellisteho (P_{nom})				9,0	kW
Vesilämmönsiirtimen teho (P_{Wnom})				---	kW
Suurin käyttöylipaine (p_w)				---	bar
Kuivan savukaasun massavirta savukaasupolun laskemiseksi				6,7	g/s
Savukaasun lämpötila (T_{nom})				326	°C
Savukaasun keskimääräinen lämpötila supistuksen jälkeen				407	°C
Savuputken veto (p_{nom})				12	Pa
Hormin lämpötilaluokka				T400	
Liitäntä yhteiseen hormiin				Kyllä	
Polttoaineen varastointialue				Ei	
Puun maksimaalinen lämpeneminen varastointialueella				---	°C
Dust O ₂ = 13 % (PM_{nom})				24	mg/Nm ³
Pölykaasupäästöt (CO savukaasuissa, O ₂ = 13 %) (CO_{nom})				0,1204 1481	% mg/Nm ³
OGC O ₂ = 13 % (OGC_{nom})				104	mg/Nm ³
NO _x O ₂ = 13 % (NO_{xnom})				87	mg/Nm ³
Automaattinen palamisen säätöyksikkö				---	
Virrankulutus (W)				---	W
Seisovan ilman häviö (V_h)				---	m ³ _N /h
Ajoittainen käyttö (INT) Jatkuva käyttö (CON)				INT	

Tekniset perustiedot

Tärkeimmät mitat Korkeus (H) Leveys (W) Pituus (L)	920 820 420	mm
Palotilan mitat Korkeus (H) Leveys (W) Pituus (L)	460 620 285	mm
Fireplace door dimensions Korkeus (H) Leveys (W) Pituus (L)	--- --- ---	mm
Takimmaisena (sivu-)ulostuloaukon korkeus	762	mm
Vesilämmönsiirtimen tilavuus	---	l
Hormin halkaisija	150	mm
Savukanavan liitännän halkaisija (D_{out})	150	mm
Ulkoilmaliitännän halkaisija		mm
Paino	176	kg
Tuloilmasäleikön pinta-ala	---	cm ²
Poistoilmasäleikön pinta-ala	---	cm ²

Suojaetäisyydet syttyviin materiaaleihin

eristämättömällä savuputkella (ilmoitettu tuotteen etiketissä)

Huomautus

Takaosa (d_R)	100	mm
Etuosa (d_P)	800	mm
Etuosasta lattiaan (d_F)	---	mm
Sivu (d_S)	100	mm
Sivu, jossa lasia (d_{S1})	---	mm
Sivu – syvennys (d_{S2})	---	mm
Sivu – sijainti 45° (d_{S3})	---	mm
Sivusäteily (d_L)	---	mm
Lattiasta (d_B)	---	mm
Katosta (d_C)	1000	mm

Suojaetäisyydet syttyviin materiaaleihin eristetyn savuputken yhteydessä *

Takaosa (d_R)	---	mm
Sivu (d_S)	---	mm

Suojaetäisyydet syttyviin materiaaleihin eristetyn savuputken yhteydessä ripustuslevyllä (suojaus) *

Takaosa (d_R)	---	mm
Sivu (d_S)	---	mm

Suojaetäisyydet syttymättömiin materiaaleihin

Takaosa (d_{Rnon})	80	mm
Sivu (d_{Snon})	100	mm
Sivu – syvennys (d_{S2non})	---	mm

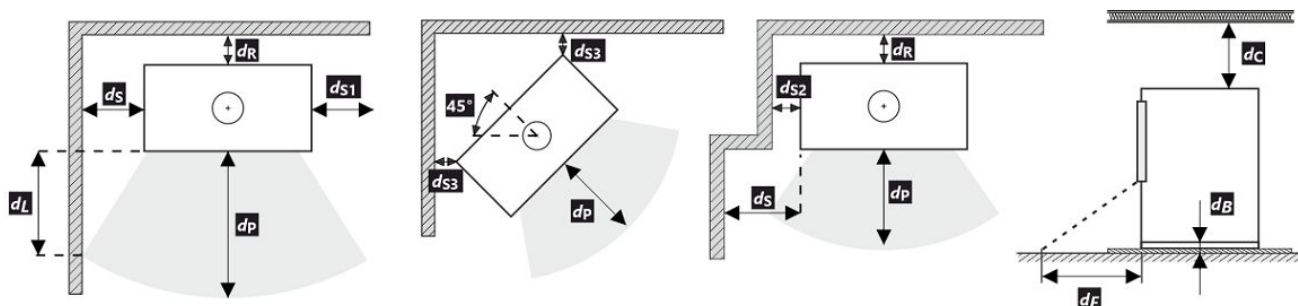

Tuotteen asennuksessa ja käytössä on noudatettava kaikkia paikallisia määräyksiä, mukaan lukien kansallisiin ja eurooppalaisiin standardeihin liittyvät määräykset.

- * Etäisyys edellyttää eristettyä savuputkea, jonka eristeen paksuus on vähintään 25 mm tuotteeseen asti.

Deklareeritud omadused

Harmoneeritud tehniline spetsifikatsioon	✓ EN 13240 EN 13229	EN 16510 ✓ Ecodesign	DIN+ BlmSchV2	DIBt ✓ 15a B-VG 2015	
Seadme klassifikatsioon				Type BE	
Energiaõhusus (N_{nom})				79,5	%
Energiaõhususe indeks				105,2	
Energiamärgis				A	
Küttematerjal				Puuhalud	
Küttematerjali pikkus				250-350	mm
Keskmine küttematerjali tarve				2,818	kg/h
Lubatud küttematerjali hulk				3,5	kg/h
Küttematerjali lisamise intervall				1 tund	
Põlemisõhu hulk				35,7	m ³ /h
Nimivõimsus (P_{nom})				9,0	kW
Soojusvaheti võimsus (P_{Wnom})				---	kW
Maksimaalne tööülerõhk (p_w)				---	bar
Suitsugaaside kuivmass suitsugaaside teekonna arvutamiseks				6,7	g/s
Suitsugaasi temperatuur (T_{nom})				326	°C
Suitsugaasi keskmine temperatuuri pärast kraed				407	°C
Suitsutoru tõmme (p_{nom})				12	Pa
Korstna temperatuuriklass				T400	
Ühendus üldkorstnaga				Jah	
Küttematerjali ladustamine puude säilitusalal				Ei	
Puidu maksimaalne soojenemine säilitusalal				---	°C
Tolm O ₂ = 13 % (PM_{nom})				24	mg/Nm ³
Põlemisgaaside emissioon suitsugaaside CO kui O ₂ = 13 % (CO_{nom})				0,1204 1481	% mg/Nm ³
OGC O ₂ = 13 % (OGC_{nom})				104	mg/Nm ³
NO _x O ₂ = 13 % (NO_{xnom})				87	mg/Nm ³
Automaatne põlemise reguleerimisseade				---	
Energiatarve (W)				---	W
Seisva õhu kadu (V_h)				---	m ³ _N /h
Vahelduv töö (INT) / Pidev töö (CON)				INT	

Tehnilised põhiandmed

Põhimõõtmed Kõrgus (H) Laius (W) Pikkus (L)	920 820 420	mm
Põlemiskambri mõõdud Kõrgus (H) Laius (W) Pikkus (L)	460 620 285	mm
Kolde ukse mõõdud Kõrgus (H) Laius (W) Pikkus (L)	--- --- ---	mm
Tagumise (külgmise) väljalaskeava telje kõrgus	762	mm
Sooja vee soojusvaheti maht	---	l
Suitsutoru diameeter	150	mm
Suitsutoru ava diameeter (D_{out})	150	mm
Välisõhu ühenduse diameeter		mm
Kaal	176	kg
Sisselaske ventilatsioonivõre	---	cm ²
Väljalaske ventilatsioonivõre	---	cm ²

Kaugus põlevatest materjalidest

isolatsioonita suitsutoruga (kirjeldatud toote etiketil)

Märkus

Tagaosa (d_R)	100	mm
Esiosa (d_P)	800	mm
Esiosast pörandani (d_F)	---	mm
Külg (d_S)	100	mm
Klaasiga külg (d_{S1})	---	mm
Külg – nišš (d_{S2})	---	mm
Külg – asend 45° (d_{S3})	---	mm
Kiirgus külje suunas (d_L)	---	mm
Pörandast (d_B)	---	mm
Laest (d_C)	1000	mm

Kaugus süttivatest materjalidest isolatsiooniga suitsutoruga *

Tagaosa (d_R)	---	mm
Külg (d_S)	---	mm

Kaugus süttivatest materjalidest isolatsiooniga suitsutoruga rippuva plaadiga (kattega) *

Tagaosa (d_R)	---	mm
Külg (d_S)	---	mm

Kaugus mittesüttivatest materjalidest

Tagaosa (d_{Rnon})	80	mm
Külg (d_{Snon})	100	mm
Külg – nišš (d_{S2non})	---	mm

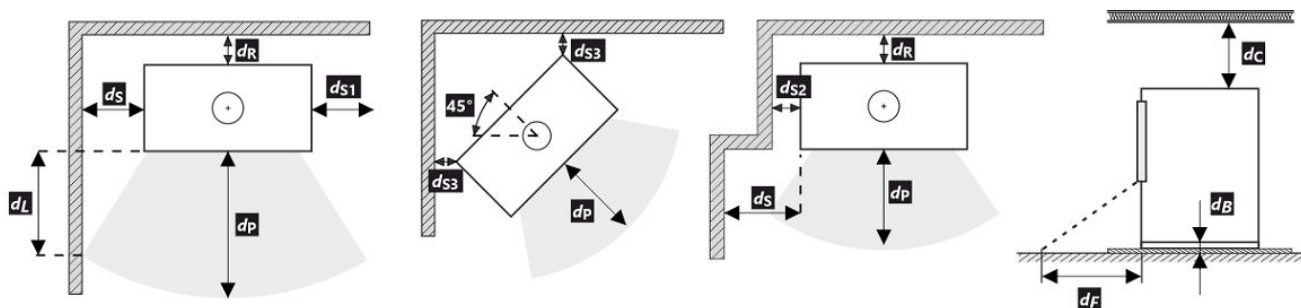

Toote paigaldamise ja kasutamise ajal tuleb järgida kõiki kohalikke määrusi, kaasa arvatud siseriiklikest ja Euroopa standarditest tulenevad määrused.

- * Kaugus eeldab isolatsiooniga suitsutoru kasutamist, millel on tooteni ulatuv, vähemalt 25 mm paksune isolatsioon.