

CENTRALNI PRIVOD VZDUCHU
Zentralluftzufuhr
Central air inlet
 $\varnothing 125\text{mm}$

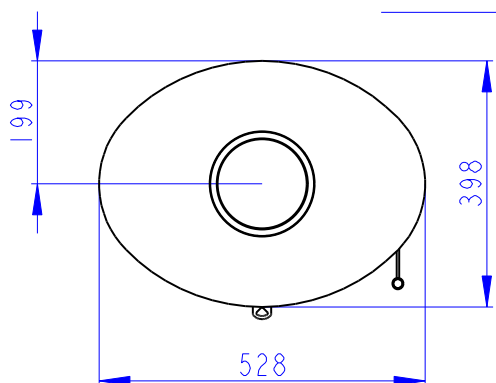

SEKUNDARNI VZDUCH
Sekundärluft
Secondary air
A/UND/AND
PRIMARNI VZDUCH
Primärluft
Primary air

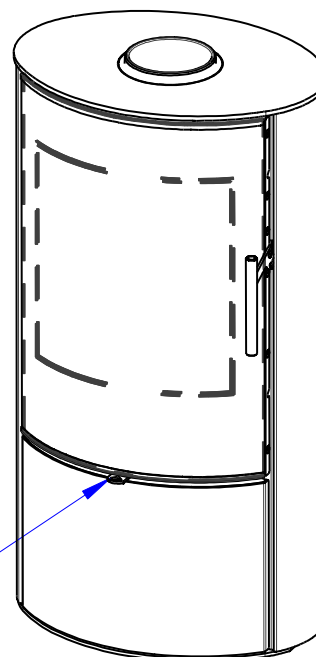

Declared qualities stated

Harmonised technical specification	✓ EN 13240 EN 13229	EN 16510 ✓ Ecodesign	✓ DIN+ ✓ BImSchV2	DIBt ✓ 15a B-VG 2015	
Classification of appliance					Type BE
Energy efficiency (η_{nom})					80,5 %
The energy efficiency index					106,8
Energy label					A
Fuel					Wood logs
Fuel length					160-280 mm
Average fuel consumption					1,269 kg/h
Allowed fuel dose					2,0 kg/h
Fuel supply interval					1 hour
Amount of combustion air					16,1 m ³ /h
Nominal output (P_{nom})					4,0 kW
Hot-water exchanger output (P_{Wnom})					--- kW
Maximum operating overpressure (p_w)					--- bar
Dry flue gas mass flow rate to calculate the flue gas path					6,4 g/s
Flue gas temperature (T_{nom})					247 °C
Mean flue gas temperature after throat					332 °C
Flue draught (p_{nom})					12 Pa
Chimney temperature class					T400
Connection to the common chimney					Yes
Storage of fuel in the wood shed area					No
Maximum warming of the wood in the wood shed					--- °C
Dust $O_2 = 13\%$ (PM_{nom})					15 mg/Nm ³
Emissions of gases of combustion (CO in the flue gases at $O_2 = 13\%$) (CO_{nom})					0,0954 % 1192 mg/Nm ³
OGC $O_2 = 13\%$ (OGC_{nom})					68 mg/Nm ³
NOx $O_2 = 13\%$ (NO_{xnom})					111 mg/Nm ³
Automatic regulation unit of burning					---
Power consumption (W)					--- W
Standing air loss (V_h)					--- m ³ _N /h
Intermittent operation (INT) / Continuous operation (CON)					INT

Basic technical data

Principal dimensions Height (H) Width (W) Length (L)	974 528 398	mm
Combustion chamber dimensions Height (H) Width (W) Length (L)	399 344 294	mm
Fireplace door dimensions Height (H) Width (W) Length (L)	--- --- ---	mm
Axis height of the rear (side) outlet	863	mm
Volume of hot-water exchanger	---	l
Flue diameter	150	mm
Diameter of flue throat (D_{out})	150	mm
Diameter of external air connection	125	mm
Weight	119	kg
Area of Inlet ventilation grille	---	cm ²
Area of Outlet ventilation grille	---	cm ²

Distances from flammable materials

with un-insulated flue pipe (provided on the product label)

Note

Back (d_R)	100	mm
Front (d_P)	800	mm
Front to the floor (d_F)	---	mm
Side (d_S)	100	mm
Side with glass (d_{S1})	---	mm
Side - niche (d_{S2})	---	mm
Side - location 45° (d_{S3})	---	mm
Side radiation (d_L)	---	mm
From the floor (d_B)	---	mm
From the ceiling (d_C)	1200	mm

Distances from flammable materials with insulated flue pipe *

Back (d_R)	---	mm
Side (d_S)	---	mm

Distances from flammable materials with insulated flue pipe and hanging plate (shielding) *

Back (d_R)	---	mm
Side (d_S)	---	mm

Distances from nonflammable materials

Back (d_{Rnon})	80	mm
Side (d_{Snon})	100	mm
Side - niche (d_{S2non})	---	mm

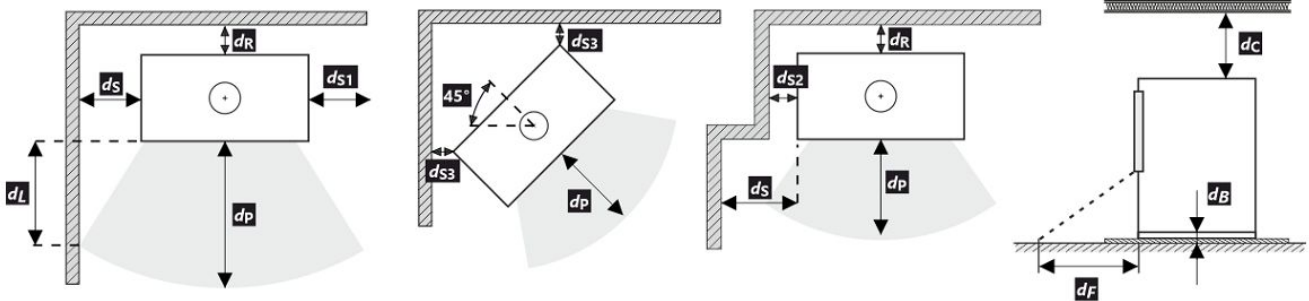

All local regulations, including regulations relating to national and European standards, must be observed during the installation and operation of the product.

- * The distance assumes the use of an insulated flue pipe with a minimum insulation thickness of 25 mm up to the product.

Deklarierte Produkteigenschaften

Harmonisierte technische Spezifikation	✓ EN 13240 EN 13229	EN 16510 ✓ Ecodesign	✓ DIN+ ✓ BImSchV2	DIBt ✓ 15a B-VG 2015
Produktklassifizierung	Type BE			
Energiewirkungsgrad (η_{nom})	80,5 %			
Energieeffizienzindex	106,8			
Energielabel	A			
Brennstoff	Scheitholz			
Brennstofflänge	160-280 mm			
Durchschnittlicher Brennstoffverbrauch	1,269 kg/h			
Zulässiger Brennstoffverbrauch	2,0 kg/h			
Brennstofflieferintervall	1 Stunde			
Verbrennungsluftmenge	16,1 m ³ /h			
Nennwärmeleistung (P_{nom})	4,0 kW			
Wärmetauscherleistung (P_{Wnom})	--- kW			
Maximaler Betriebsüberdruck (p_w)	--- bar			
Rauchgasmassenstrom (trocken) für die Berechnung der Rauchgaswege	6,4 g/s			
Durchschnittliche Abgastemperatur (T_{nom})	247 °C			
Durchschnittliche Rauchgastemperatur hinter dem Stutzen	332 °C			
Förderdruck (p_{nom})	12 Pa			
Temperaturklasse	T400			
Mehrfachbelegung	Ja			
Lagerung von Brennstoff im Holzfach	Nein			
Maximale Erwärmung des Holzes im Holzfach	--- °C			
Feinstaub O ₂ = 13 % (PM_{nom})	15 mg/Nm ³			
Abgasemission (CO in den Abgasen bei O ₂ = 13 %) (CO_{nom})	0,0954 % 1192 mg/Nm ³			
OGC O ₂ = 13 % (OGC_{nom})	68 mg/Nm ³			
NO _x O ₂ = 13 % (NO_{xnom})	111 mg/Nm ³			
Automatische Abbrandsteuerung	---			
Stromverbrauch (W)	--- W			
Ständiger Luftverlust (V_h)	--- m ³ _N /h			
Intervallbetrieb (INT) / Dauerbetrieb (CON)	INT			

Technische Grunddaten

Hauptabmessungen Höhe (H) Breite (W) Tiefe (L)	974 528 398	mm
Abmessungen der Brennkammer Höhe (H) Breite (W) Tiefe (L)	399 344 294	mm
Abmessungen der Feuerraumtür Höhe (H) Breite (W) Tiefe (L)	--- --- ---	mm
Achshöhe hinterer (seitlichen) Rauchrohanschluss	863	mm
Volumen Wärmetauscher	---	l
Rauchrohrdurchmesser	150	mm
Abgasstutzen (D_{out})	150	mm
Durchmesser zentrale Luftzufuhr	125	mm
Gewicht	119	kg
Fläche Zuluftgitter	---	cm ²
Fläche Abluftgitter	---	cm ²

Abstand zu brennbaren Materialien

mit unisoliertem Rauchrohr (auf dem Typenschild angegeben)

Bemerkung

Rückwand (d_R)	100	mm
Strahlungsbereich (d_P)	800	mm
Strahlungsbereich zum Boden (d_F)	---	mm
Seitenwände (d_S)	100	mm
Seite mit Glas (d_{S1})	---	mm
Seite – Nische (d_{S2})	---	mm
Seite – Ausrichtung 45° (d_{S3})	---	mm
Seitliche Strahlung (d_L)	---	mm
Von dem Boden (d_B)	---	mm
Von der Decke (d_C)	1200	mm

Abstand zu brennbaren Materialien mit isoliertem Rauchrohr *

Rückwand (d_R)	---	mm
Seitenwände (d_S)	---	mm

Abstand zu brennbaren Materialien mit isoliertem Rauchrohr und Aufhängeblech (Abschirmung) *

Rückwand (d_R)	---	mm
Seitenwände (d_S)	---	mm

Abstand zu nicht brennbaren Materialien

Rückwand (d_{Rnon})	80	mm
Seitenwände (d_{Snon})	100	mm
Seite – Nische (d_{S2non})	---	mm

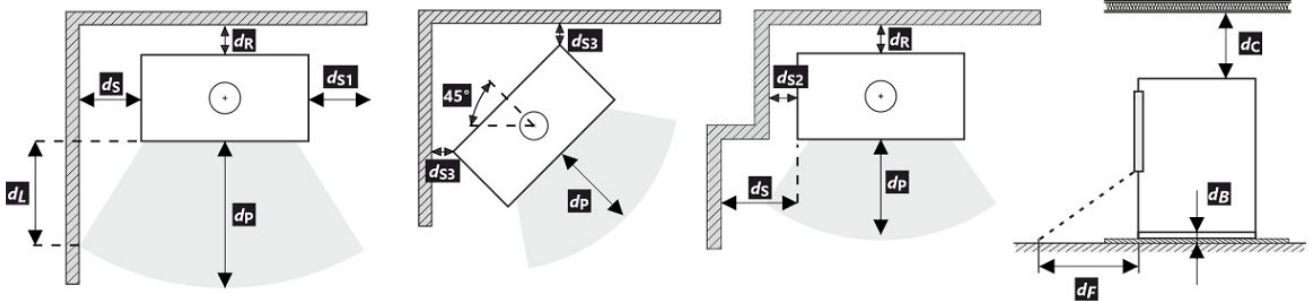

Bei der Installation und dem Betrieb des Ofens sind alle örtlichen Vorschriften sowie nationale und europäische Normen zu beachten.

- * Der Abstand setzt die Verwendung eines isolierten Rauchrohrs mit einer Mindestdämmstärke von 25 mm bis zum Produkt voraus.

Caractéristiques déclarées du produit

Norme(s) Européennes	✓ EN 13240 EN 13229	EN 16510 ✓ Ecodesign	✓ DIN+ ✓ BImSchV2	DIBt ✓ 15a B-VG 2015
Classification de l'appareil	Type BE			
Rendement énergétique (N_{nom})				80,5 %
L'indice d'efficacité énergétique EEI				106,8
Label énergétique				A
Combustible				Bûches
Longueur recommandée de bûches				160-280 mm
Consommation moyenne de combustible				1,269 kg/h
Charge en bois autorisé				2,0 kg/h
Intervalle entre les chargements de combustible				1 heure
Débit massique des fumées				16,1 m ³ /h
Puissance nominale (P_{nom})				4,0 kW
Puissance nominale de l'échangeur (P_{Wnom})				---
Surpression maximale de fonctionnement (p_w)				---
Débit massique des gaz de combustion secs pour le calcul des gaz de combustion				6,4 g/s
Température moyenne des résidus de combustion (T_{nom})				247 °C
Température moyenne des résidus de combustion derrière la sortie				332 °C
Tirage de conduit de fumée (p_{nom})				12 Pa
Classe de température				T400
Raccordement à une cheminée collective				Oui
Stockage du combustible dans range bûches				Non
Réchauffement maximal du bois dans range bûches				---
Poussière O ₂ = 13 % (PM_{nom})				15 mg/Nm ³
Résidus de combustion émis (CO dans les résidus de combustion pour O ₂ = 13 %) (CO_{nom})				0,0954 % 1192 mg/Nm ³
OGC O ₂ = 13 % (OGC_{nom})				68 mg/Nm ³
NOx O ₂ = 13 % (NO_{xnom})				111 mg/Nm ³
Régulation automatique de la combustion				---
La consommation d'électricité (W)				---
Standing air loss (V_h)				---
Fonctionnement par intermittence (INT) / Service ininterrompu (CON)				INT

Données techniques de base

Dimensions principales Hauteur (H) Largeur (W) Profondeur (L)	974 528 398	mm
Dimensions de la chambre de combustion Hauteur (H) Largeur (W) Profondeur (L)	399 344 294	mm
Dimensions de la porte (du foyer) Hauteur (H) Largeur (W) Profondeur (L)	--- --- ---	mm
Hauteur de l'axe de la sortie arrière (latérale)	863	mm
Volume de l'échangeur de chaleur	---	l
Diamètre du conduit de fumée	150	mm
Diamètre de buse d'air de combustion (D_{out})	150	mm
Diamètre de l'arrivée d'air centrale	125	mm
Poids	119	kg
Zone de la grille de ventilation d'entrée	---	cm ²
Zone de la grille de ventilation de sortie	---	cm ²

Distance par rapport aux matériaux combustibles

pour un conduit de fum. non isolé (conform. aux la plaque signalétique)

Note

Arrière (d_R)	100	mm
Avant (d_P)	800	mm
Avant (par rapport au sol) (d_F)	---	mm
Latéral (d_S)	100	mm
Latéral avec vitre (d_{S1})	---	mm
Latéral – niche (d_{S2})	---	mm
Latéral – emplacement 45° (d_{S3})	---	mm
Rayonnement latéral (d_L)	---	mm
Depuis le sol (d_B)	---	mm
Plafond (d_C)	1200	mm

Distance par rapport aux matériaux combustibles pour un conduit de fumée isolé *

Arrière (d_R)	---	mm
Latéral (d_S)	---	mm

Distance par rapport aux matériaux combustibles pour un conduit de fumée isolé une plaque de suspension *

Arrière (d_R)	---	mm
Latéral (d_S)	---	mm

Distance par rapport aux matériaux non combustibles

Arrière (d_{Rnon})	80	mm
Latéral (d_{Snon})	100	mm
Latéral – niche (d_{S2non})	---	mm

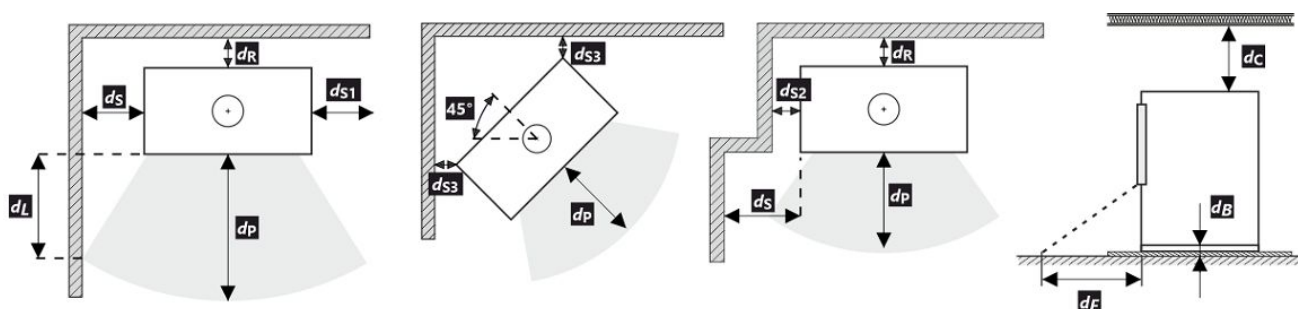

Lors de l'installation et de l'utilisation du produit, toutes les réglementations locales doivent être respectées, y compris celles relatives aux normes nationales et européennes.

- * La distance suppose l'utilisation d'un conduit de fumée isolé avec une épaisseur d'isolation minimale de 25 mm jusqu'au produit.

Proprietà dichiarate del prodotto

Specificazioni tecniche armonizzate	✓ EN 13240 EN 13229	EN 16510 ✓ Ecodesign	✓ DIN+ ✓ BImSchV2	DIBt ✓ 15a B-VG 2015	
Classificazione del prodotto					Type BE
Efficienza energetica (η_{nom})					80,5 %
Indice di efficienza prodotto					106,8
Etichetta energetica					A
Combustibile					Legna
Combustibile – lunghezza					160-280 mm
Consumo medio di combustibile					1,269 kg/h
Dose ammessa di combustibile					2,0 kg/h
Intervallo di aggiunta di combustibile					1 ora
Quantità di aria di combustione					16,1 m ³ /h
Protenza nominale (P_{nom})					4,0 kW
Protenza nominale dello scambiatore di acqua calda (P_{Wnom})					--- kW
Sovrappressione massima di funzionamento (p_w)					--- bar
Portata dei fumi di scarico secchi per il calcolo delle condotte dei fumi di scarico					6,4 g/s
Temperatura dei gas combusti alla potenza calorica nominale (T_{nom})					247 °C
Temp. media dei gas di scarico al collo alla potenza termica nominale					332 °C
Tiro di esercizio (p_{nom})					12 Pa
Classe di temperatura del camino					T400
Collegamento al camino collettivo					Sì
Stoccaggio del combustibile nell'area della stufa a legna					No
Riscaldamento massimo della legna nella stufa a legna					--- °C
Polvere O ₂ = 13 % (PM_{nom})					15 mg/Nm ³
Emissioni (CO nei gas comburenti all' O ₂ = 13 %)(CO_{nom})					0,0954 % 1192 mg/Nm ³
OGC O ₂ = 13 % (OGC_{nom})					68 mg/Nm ³
NOx O ₂ = 13 % (NO_{Xnom})					111 mg/Nm ³
Controllo automatico della combustione					---
Consumo di energia elettrica (W)					--- W
Perdita d'aria in piedi (V_h)					--- m ³ /h
Funzionamento intermittente (INT) / Funzionamento continuo (CON)					INT

Dati tecnici di base

Dimensioni principali Altezza (H) Larghezza (W) Profondità (L)	974 528 398	mm
Dimensioni della camera di combustione Altezza (H) Larghezza (W) Profondità (L)	399 344 294	mm
Dimensioni dello sportello del focolare Altezza (H) Larghezza (W) Profondità (L)	--- --- ---	mm
Altezza dell'asse dell'uscita posteriore (laterale)	863	mm
Volume dello scambiatore di aqua calda	---	l
Diametro del condotto fumario	150	mm
Diametro del gola della canna fumaria (D_{out})	150	mm
Diametro dell'afflusso centralizzato di aria	125	mm
Peso	119	kg
Superficie della griglia di aerazione d'ingresso	---	cm ²
Superficie della griglia di aerazione d'uscita	---	cm ²

Distanza di materiali infiammabili

con canna fumaria non isolata (indicato sull'etichetta di produzione)

Nota

Posteriore (d_R)	100	mm
Anteriore (d_P)	800	mm
Anteriore (rispetto al pavimento) (d_F)	---	mm
Laterali (d_S)	100	mm
Vetrata laterale (d_{S1})	---	mm
Laterali - nicchia (d_{S2})	---	mm
Laterali - posizione 45° (d_{S3})	---	mm
Radiazione laterale (d_L)	---	mm
Dal pavimento (d_B)	---	mm
Dal soffitto (d_C)	1200	mm

Distanza di materiali infiammabili con canna fumaria isolata *

Posteriore (d_R)	---	mm
Laterali (d_S)	---	mm

Distanza di materiali infiammabili con canna fumaria isolata una piastra di sospensione *

Posteriore (d_R)	---	mm
Laterali (d_S)	---	mm

Distanza di materiali non infiammabili

Posteriore (d_{Rnon})	80	mm
Laterali (d_{Snon})	100	mm
Laterali - nicchia (d_{S2non})	---	mm

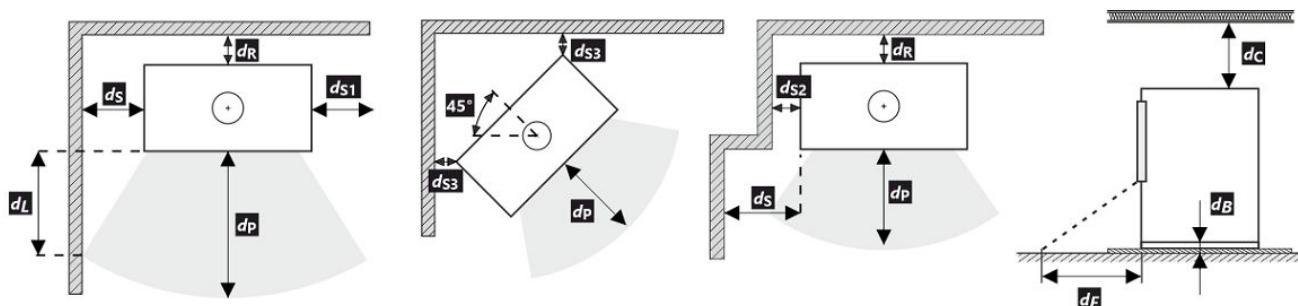

Durante il montaggio e l'uso del prodotto, devono essere rispettate tutte le normative locali, incluse le norme nazionali ed europee.

- * La distanza presuppone l'utilizzo di una canna fumaria isolata con uno spessore minimo di isolamento di 25 mm fino al prodotto.

Deklaracija lastnosti

Harmonizirana tehnična specifikacija	✓ EN 13240 EN 13229	EN 16510 ✓ Ecodesign	✓ DIN+ ✓ BlmSchV2	DIBt ✓ 15a B-VG 2015
Klasifikacija izdelka	Type BE			
Energetska učinkovitost (N_{nom})	80,5			%
Indeks energetske učinkovitosti	106,8			
Energijska nalepka	A			
Gorivo	Drva			
Priporočljiva dolžina goriva	160-280			mm
Povprečna poraba lesa	1,269			kg/h
Dovoljena količina lesa	2,0			kg/h
Interval dobave goriva za nazivno moč	1 ura			
Zahtevan zrak za izgorevanje	16,1			m ³ /h
Nazivna moč (P_{nom})	4,0			kW
Izhod toplovodnega izmenjevalnika (P_{Wnom})	---			kW
Delovni tlak (p_w)	---			bar
Masni pretok huhih dimnih plinov	6,4			g/s
Srednja temperatura plinov pri nazivni toplotni moči (T_{nom})	247			°C
Srednja temperatura dimnih plinov po grlu pri nazivni toplotni moči	332			°C
Vlek dimnika (p_{nom})	12			Pa
Temperaturni razred kamina	T400			
Priključek na skupni dimnik	Da			
Skladiščenje goriva v območju peči	Ne			
Maksimalno segrevanje lesa v območju peči na drva	---			°C
Prah O ₂ = 13 % (PM_{nom})	15			mg/Nm ³
Emisije izgorevalnih plinov (CO v dimne pline pri O ₂ = 13 %) (CO_{nom})	0,0954 1192			% mg/Nm ³
OGC O ₂ = 13 % (OGC_{nom})	68			mg/Nm ³
NO _x O ₂ = 13 % (NO_{xnom})	111			mg/Nm ³
Avtomatska regulacija gorenja	---			
Poraba električne energije (W)	---			W
Stalna izguba zraka (V_h)	---			m ³ /h
Prekinjeno delovanje (INT) / Nprekinjeno delovanje (CON)	INT			

Osnovni tehnični podatki

Dimenzije Višina (H) Širina (W) Globina (L)	974 528 398	mm
Dimenzije zgorevalne komore Višina (H) Širina (W) Globina (L)	399 344 294	mm
Dimenzije vrat peči Višina (H) Širina (W) Globina (L)	--- --- ---	mm
Višina osi zadnjega (stranskega) izpusta	863	mm
Prostornina toplotnega izmenjevalnika	---	l
Premer priključka dimne cevi	150	mm
Premer dimne cevi (D_{out})	150	mm
Zunanji dovod zraka (ZDZ)	125	mm
Teža	119	kg
Minimalni presek konvektne odprtine za dovod zraka za nazivno moč	---	cm ²
Minimalni presek konvektne odprtine za odvod zraka za nazivno moč	---	cm ²

Varna razdalja od vnetljivega materiala

z neizolirano dimovodno cevjo (navedeno na nalepki izdelka)

Opomba

Zadaj (d_R)	100	mm
Spredaj (d_P)	800	mm
Spredaj do tal (d_F)	---	mm
Stran (d_S)	100	mm
Stran s steklom (d_{S1})	---	mm
Stran – niša (d_{S2})	---	mm
Stran – postavitvev pod kotom 45° (d_{S3})	---	mm
Stransko sevanje (d_L)	---	mm
Od tal (d_B)	---	mm
Od stropa (d_C)	1200	mm

Varna razdalja od vnetljivega materiala z izolirano dimovodno cevjo *

Zadaj (d_R)	---	mm
Stran (d_S)	---	mm

Varna razdalja od vnetljivega materiala z izolirano dimovodno cevjo s pokrивно ploščo (pokrovom) *

Zadaj (d_R)	---	mm
Stran (d_S)	---	mm

Varna razdalja od negorljivega materiala

Zadaj (d_{Rnon})	80	mm
Stran (d_{Snon})	100	mm
Stran – niša (d_{S2non})	---	mm

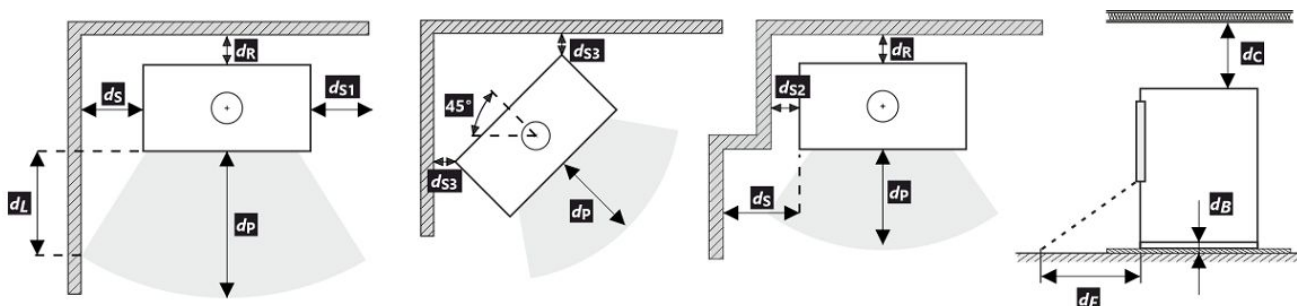

Pri montaži in delovanju izdelka morajo biti upoštevani vsi lokalni predpisi, vključno predpisi, ki se nanašajo na lokalne in Evropske standarde.

- * Razdalja predpostavlja uporabo izolirane dimovodne cevi z najmanjšo debelino izolacije 25 mm do izdelka.

Ilmoitetut ominaisuudet

Yhdenmukaistetut tekniset tiedot	✓ EN 13240 EN 13229	EN 16510 ✓ Ecodesign	✓ DIN+ ✓ BImSchV2	DIBt ✓ 15a B-VG 2015	
Laitteen luokittelu				Type BE	
Energiatehokkuus (N_{nom})				80,5	%
Energiatehokkuusindeksi				106,8	
Energiamerkintä				A	
Polttoaine				Puuhalot	
Polttopuun pituus				160-280	mm
Keskimääräinen polttoaineenkulutus				1,269	kg/h
Sallittu puumäärä				2,0	kg/h
Puun lisäysväli				1 tunti	
Palamisilman määrä				16,1	m ³ /h
Nimellisteho (P_{nom})				4,0	kW
Vesilämmönsiirtimen teho (P_{Wnom})				---	kW
Suurin käyttöylipaine (p_w)				---	bar
Kuivan savukaasun massavirta savukaasupolun laskemiseksi				6,4	g/s
Savukaasun lämpötila (T_{nom})				247	°C
Savukaasun keskimääräinen lämpötila supistuksen jälkeen				332	°C
Savuputken veto (p_{nom})				12	Pa
Hormin lämpötilaluokka				T400	
Liitäntä yhteiseen hormiin				Kyllä	
Polttoaineen varastointialue				Ei	
Puun maksimaalinen lämpeneminen varastointialueella				---	°C
Dust O ₂ = 13 % (PM_{nom})				15	mg/Nm ³
Pölykaasupäästöt (CO savukaasuissa, O ₂ = 13 %) (CO_{nom})				0,0954 1192	% mg/Nm ³
OGC O ₂ = 13 % (OGC_{nom})				68	mg/Nm ³
NO _x O ₂ = 13 % (NO_{xnom})				111	mg/Nm ³
Automaattinen palamisen säätöyksikkö				---	
Virrankulutus (W)				---	W
Seisovan ilman häviö (V_h)				---	m ³ _N /h
Ajoittainen käyttö (INT) Jatkuva käyttö (CON)				INT	

Tekniset perustiedot

Tärkeimmät mitat Korkeus (H) Leveys (W) Pituus (L)	974 528 398	mm
Palotilan mitat Korkeus (H) Leveys (W) Pituus (L)	399 344 294	mm
Fireplace door dimensions Korkeus (H) Leveys (W) Pituus (L)	--- --- ---	mm
Takimmaisena (sivu-)ulostuloaukon korkeus	863	mm
Vesilämmönsiirtimen tilavuus	---	l
Hormin halkaisija	150	mm
Savukanavan liitännän halkaisija (D_{out})	150	mm
Ulkoilmaliitännän halkaisija	125	mm
Paino	119	kg
Tuloilmasäleikön pinta-ala	---	cm ²
Poistoilmasäleikön pinta-ala	---	cm ²

Suojaetäisyydet syttyviin materiaaleihin

eristämättömällä savuputkella (ilmoitettu tuotteen etiketissä)

Huomautus

Takaosa (d_R)	100	mm
Etuosa (d_P)	800	mm
Etuosasta lattiaan (d_F)	---	mm
Sivu (d_S)	100	mm
Sivu, jossa lasia (d_{S1})	---	mm
Sivu – syvennys (d_{S2})	---	mm
Sivu – sijainti 45° (d_{S3})	---	mm
Sivusäteily (d_L)	---	mm
Lattiasta (d_B)	---	mm
Katosta (d_C)	1200	mm

Suojaetäisyydet syttyviin materiaaleihin eristetyn savuputken yhteydessä *

Takaosa (d_R)	---	mm
Sivu (d_S)	---	mm

Suojaetäisyydet syttyviin materiaaleihin eristetyn savuputken yhteydessä ripustuslevyllä (suojaus) *

Takaosa (d_R)	---	mm
Sivu (d_S)	---	mm

Suojaetäisyydet syttymättömiin materiaaleihin

Takaosa (d_{Rnon})	80	mm
Sivu (d_{Snon})	100	mm
Sivu – syvennys (d_{S2non})	---	mm

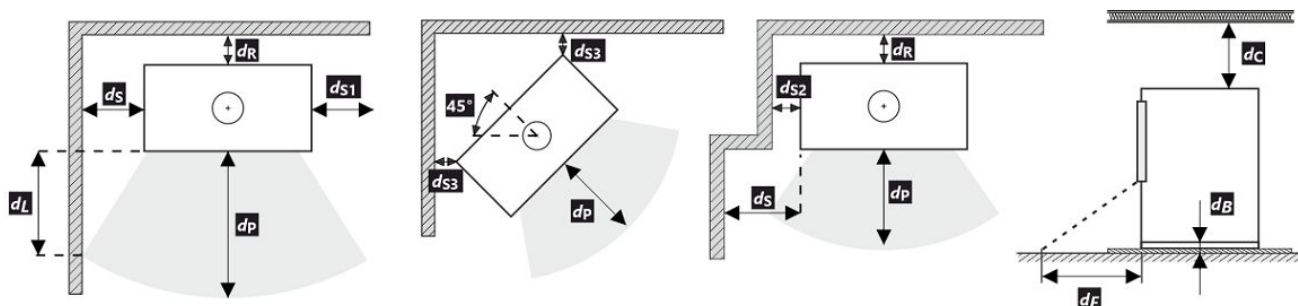

Tuotteen asennuksessa ja käytössä on noudatettava kaikkia paikallisia määräyksiä, mukaan lukien kansallisiin ja eurooppalaisiin standardeihin liittyvät määräykset.

- * Etäisyys edellyttää eristettyä savuputkea, jonka eristeen paksuus on vähintään 25 mm tuotteeseen asti.

Deklareeritud omadused

Harmoneeritud tehniline spetsifikatsioon	✓ EN 13240 EN 13229	EN 16510 ✓ Ecodesign	✓ DIN+ ✓ BImSchV2	DIBt ✓ 15a B-VG 2015	
Seadme klassifikatsioon				Type BE	
Energiatõhusus (η_{nom})				80,5	%
Energiatõhususe indeks				106,8	
Energiamärgis				A	
Küttematerjal				Puuhalud	
Küttematerjali pikkus				160-280	mm
Keskmine küttematerjali tarve				1,269	kg/h
Lubatud küttematerjali hulk				2,0	kg/h
Küttematerjali lisamise intervall				1 tund	
Põlemisõhu hulk				16,1	m ³ /h
Nimivõimsus (P_{nom})				4,0	kW
Soojusvaheti võimsus (P_{Wnom})				---	kW
Maksimaalne tööülerõhk (p_w)				---	bar
Suitsugaaside kuivmass suitsugaaside teekonna arvutamiseks				6,4	g/s
Suitsugaasi temperatuur (T_{nom})				247	°C
Suitsugaasi keskmine temperatuuri pärast kraed				332	°C
Suitsutoru tõmme (p_{nom})				12	Pa
Korstna temperatuuriklass				T400	
Ühendus üldkorstnaga				Jah	
Küttematerjali ladustamine puude säilitusalal				Ei	
Puidu maksimaalne soojenemine säilitusalal				---	°C
Tolm O ₂ = 13 % (PM_{nom})				15	mg/Nm ³
Põlemisgaaside emissioon suitsugaaside CO kui O ₂ = 13 % (CO_{nom})				0,0954 1192	% mg/Nm ³
OGC O ₂ = 13 % (OGC_{nom})				68	mg/Nm ³
NO _x O ₂ = 13 % (NO_{xnom})				111	mg/Nm ³
Automaatne põlemise reguleerimisseade				---	
Energiatarve (W)				---	W
Seisva õhu kadu (V_h)				---	m ³ _N /h
Vahelduv töö (INT) / Pidev töö (CON)				INT	

Tehnilised põhiandmed

Põhimõõtmed	974 528 398	mm
Kõrgus (H) Laius (W) Pikkus (L)		
Põlemiskambri mõõdud	399 344 294	mm
Kõrgus (H) Laius (W) Pikkus (L)		
Kolde ukse mõõdud	---	mm
Kõrgus (H) Laius (W) Pikkus (L)		
Tagumise (külgmise) väljalaskeava telje kõrgus	863	mm
Sooja vee soojusvaheti maht	---	l
Suitsutoru diameeter	150	mm
Suitsutoru ava diameeter (D_{out})	150	mm
Välisõhu ühenduse diameeter	125	mm
Kaal	119	kg
Sisselaske ventilatsioonivõre	---	cm ²
Väljalaske ventilatsioonivõre	---	cm ²

Kaugus põlevatest materjalidest

isolatsioonita suitsutoruga (kirjeldatud toote etiketil)

Märkus

Tagaosa (d_R)	100	mm
Esiosa (d_P)	800	mm
Esiosast pörandani (d_F)	---	mm
Külg (d_S)	100	mm
Klaasiga külg (d_{S1})	---	mm
Külg – nišš (d_{S2})	---	mm
Külg – asend 45° (d_{S3})	---	mm
Kiirgus külje suunas (d_L)	---	mm
Pörandast (d_B)	---	mm
Laest (d_C)	1200	mm

Kaugus süttivatest materjalidest isolatsiooniga suitsutoruga *

Tagaosa (d_R)	---	mm
Külg (d_S)	---	mm

Kaugus süttivatest materjalidest isolatsiooniga suitsutoruga rippuva plaadiga (kattega) *

Tagaosa (d_R)	---	mm
Külg (d_S)	---	mm

Kaugus mittesüttivatest materjalidest

Tagaosa ($d_{R_{non}}$)	80	mm
Külg ($d_{S_{non}}$)	100	mm
Külg – nišš ($d_{S2_{non}}$)	---	mm

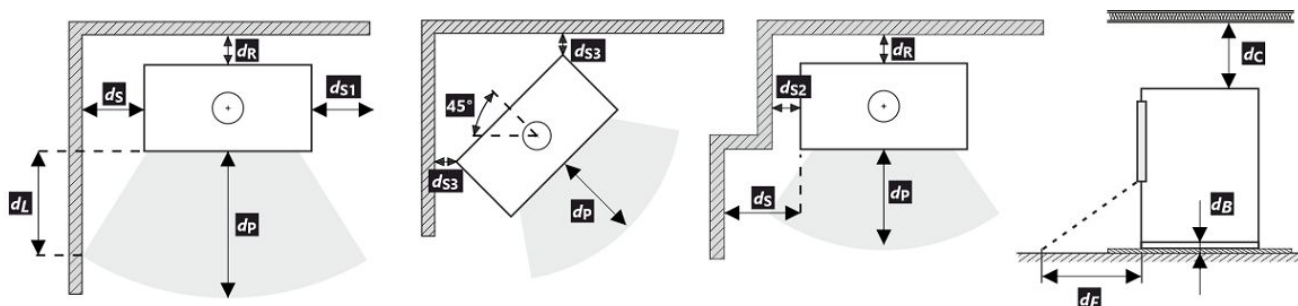

Toote paigaldamise ja kasutamise ajal tuleb järgida kõiki kohalikke määrusi, kaasa arvatud siseriiklikest ja Euroopa standarditest tulenevad määrused.

- * Kaugus eeldab isolatsiooniga suitsutoru kasutamist, millel on tooteni ulatuv, vähemalt 25 mm paksune isolatsioon.